



NUESTROS LANZAMIENTOS - ZM



ZM 3-665

Tensión 12V , Terminal B+ M8 , Nota2 Conector , Nota3 , Sistema: Denso

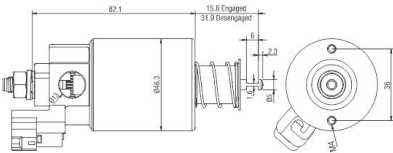

Toyota : Etios 2013>

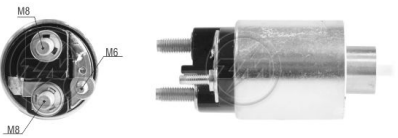

ZM 3-795

Tensión 12V , Terminal B+ M8 , Terminal Motor M8 , Terminal Ignición M6 , Sistema: Mitsubishi

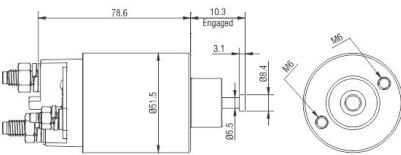

Ford : Explorer
Ford : Focus 2012>
Ford : Mondeo
Ford : Escape 2013>

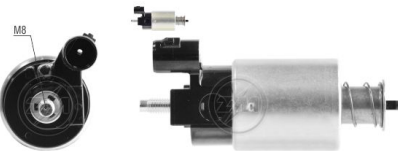

ZM 4-665

Tensión 12V , Terminal B+ M8 , Terminal Motor - , Terminal Ignición Conector , Sistema: Denso

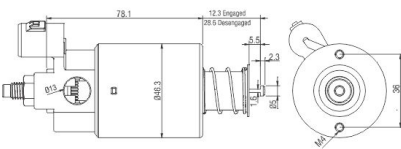

Dodge : Ram 1500 V6 3.6 - 2015>
Jeep : Wrangler V6 3.6L 220 CID - 2012>

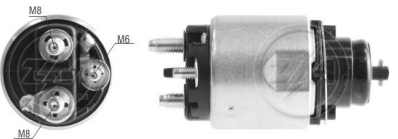

ZM 7-494

Tensión 12V , Terminal B+ M8 , Terminal Motor , Terminal Ignición , Sistema: Valeo

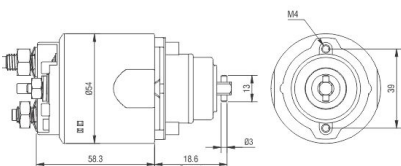

Chevrolet : S10
Chevrolet : Trailblazer

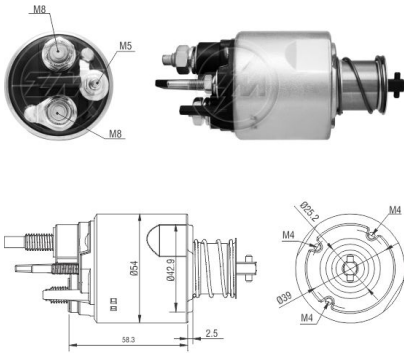

ZM 8-494

Tensión 12V , Terminal B+ M8 , Terminal Motor M8 , Terminal Ignición M5 , Sistema: Valeo

Renault : Clio 1.6 16V

Renault : Kangoo 1.6 16V

Renault : Megane 1.6 16V

Renault : Laguna

Renault : Scenic 1.6 16V c/motor K4M

Renault : Logan 1.4 MPI c/motor K7J710

Renault : Logan 1.6 16V c/motores K4M690, K4M694

Renault : Sandero 1.4, 1.6 16V

Renault : Duster 1.6 16V 2007>2015

Pedro Nossovich y Cía.

Administración:

📍 Bv. Alvear 400. (X5900FWH) Villa María, Cba. Argentina.

☎ Tel. +54 (0353) 453.3555 📠 Fax +54 (0353) 453.4555

📠 Fax Pedidos: 0800-444-66776 ✉ info@nosso.com

Fábrica:

📍 Bv. Sarmiento 1239 (X5900AXC)

Villa María, Cba. Argentina.

☎ Tel./Fax +54 (0353) 453.3556



nosso.com